







<b>APPROVAL</b>		
<b>Electrical</b>		
Standard	<b>UL</b>	<b>IEC</b>
Rated voltage	300V	250V
Rated current	12A	15A
Wire range	26-14AWG	1.5mm <sup>2</sup>
Withstanding voltage	AC2000V/1Min	
<b>Menchanical</b>		
Torque	0.4Nm(3.5Lb-In)	
Ambient temperature	-40°C~+105 °C	
Strip length	6mm	
<b>Dimensions</b>		
pitch	5.0mm(.197" ) 5.08mm(.200" )	
Poles	2P,3P-24P	
<b>Material</b>		
Housing	PA66,UL94V-0	
Screws	M2.5,Steel, Cr <sup>3+</sup> Znplated	
Pin header	Brass,Tin-plated	
Cage	Brass,Ni-plated	

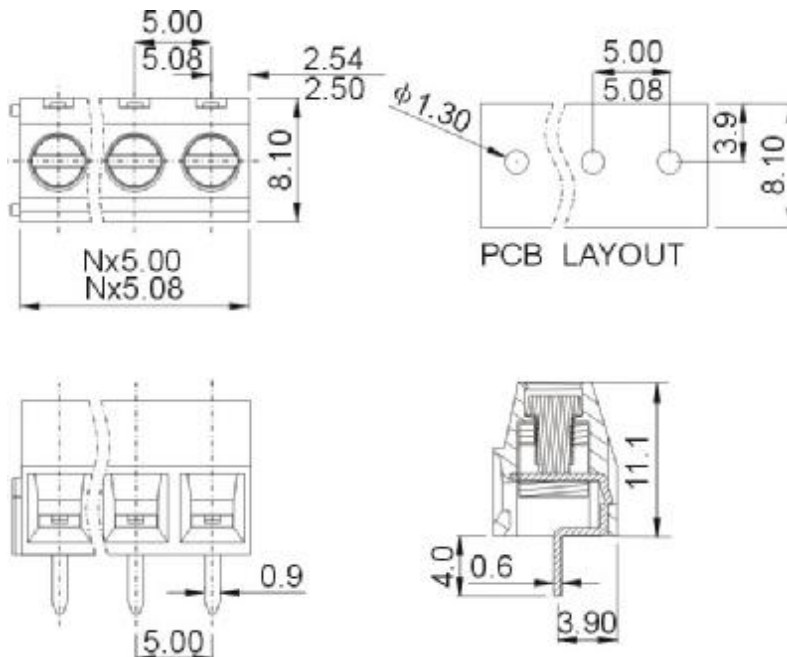
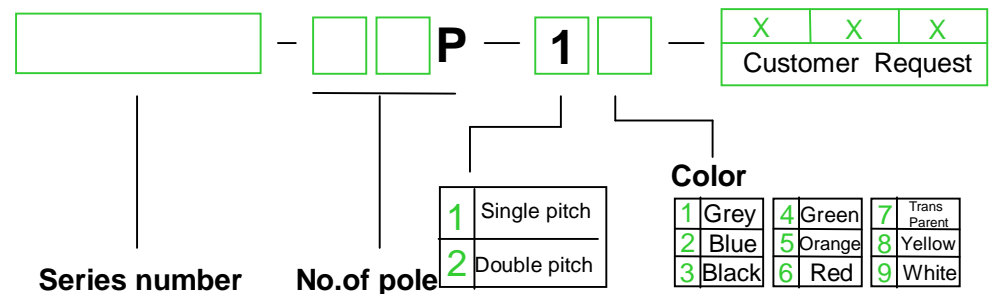

### HOW TO ORDER :

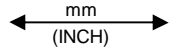

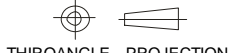
	 <b>DEGSON ELECTRONICS CO., LTD.</b>
	<b>NAME</b> <b>DG127-5.0</b> <b>DG127-5.08</b>